



CO₂ POWERED ENERGY MAX 1.3J
 Muzzle Velocity 100m/s (328FPS)
HI-CAPA CARNOTAURUS

Please read the [Instruction Manual] carefully and make full understanding of the details noted in the contents before use.

WARNING

- To avoid damaging the product, please release the gas from the magazines or cartridges while not operating.
- Sales and usage are restricted to 18-year-old people or older. Those below 18 years old are not allowed neither to purchase nor to operate alone.
- Never aim or shoot at people or animals. Please beware of childrens' mis-handling.
- Please read and fully understand all details listed in this instruction manual before using this air gun. You can download it from www.icsbb.com if you lose this instruction manual.

1 PART DESCRIPTION

WARNING-ATTENTION

This model is featured with Gas-Blow-Back function. The slide will be pushed backward by the gas pressure strongly and rapidly while firing. To prevent injury, please keep your face and finger away from the slide.

- The pistol could be damaged when using at temperature of 30° C (86° F) or above.

2 SAFETY DEVICE

- Safety ON**
Engage the safety by cocking down the hammer then pressing up on the safety lever.
 ※ The trigger and slide can not be pulled when the safety is engaged.
 ※ Please press up the safety lever only when the hammer is cocked, or damage might be caused.
- Safety OFF**
Disengage the safety when you are going to fire.

■ The trigger cannot be pulled without holding the grip safety.

■ The trigger can be pulled when holding the grip safety firmly.

3 LOADING MAGAZINE

WARNING-ATTENTION

- To prevent misfiring, keep your finger off the trigger and out of the trigger guard while loading the magazine.
- For safety reason, please remove the magazine while not operating.

■ Load the magazine until it clicks into the locking position.
 ※ Do not insert the magazine by force.

■ Release the magazine by pressing the magazine catch button.
 ※ Hold the magazine when releasing it from the pistol grip to prevent it from dropping.

4 CO2 CARTRIDGE INSTALLATION

- Remove the magazine buttpad.
- Use the Allen key to loosen the fixing screw.
- Insert the cartridge into the magazine.
 ※ Warning! Do not throw it into the magazine to avoid the danger.
- Fasten the cartridge fixing screw.
 ※ Warning! The magazine has a decompression hole, do not aim at the eyes when you rotate the fixing screw.
- Install the magazine buttpad then ready to use.

WARNING-ATTENTION

To avoid the overheating of the cartridges, the cartridges should be stored in cool, dry place and away from the heat source, which must below 31° C, in case the inflation of volume and generate high-pressure gas due to temperature uprising of the content liquid CO₂, which will deal greater pressure to the cartridges, and lead to the risk of explosion.

WARNING

● The slide will be blown back and forth when firing.

5 LOADING BBs

- Do not release the magazine follower abruptly while pressing the follower. Releasing the follower carelessly may damage the magazine lip.

● Leave no gap between BBs

● You may insert the last BB through the magazine lip.
 ※ Do not attempt to insert more than 30 BBs into the magazine.

WARNING-ATTENTION

● Pull the magazine follower down to the end, insert BBs into the BB slot. (30 rounds MAX)

● Do not release the magazine follower abruptly while pressing the follower. Releasing the follower carelessly may damage the magazine lip.

6 Trigger Pull Adjustment

Please use a 2mm Allen wrench to adjust the trigger pull hex screw.
 ※ Please adjust according to personal habit.
 △ The trigger could be locked by fastening the hex screw to the end, please release the screw properly.

7 Loading

- Insert the magazine.
- Pull the slide to the end and hold (the hammer will be pressed down).
- Release the slide (the slide is held at the back at the moment).
- Press the slide catch downward, the slide will be pushed forward (a BB pellet will be loaded into the barrel).

WARNING-ATTENTION

- Keep your face and fingers away from the slide while the slide is operating.
- When the magazine is detached, the slide stop will not lock the slide spontaneously after your releasing the slide.
- When the pistol is loaded, loading repeatedly will makes the BBs load into the barrel repeatedly, which will lead to malfunction while firing and cause danger.
- When the hammer is pressed down, pulling the trigger will fire the bb. Please take extra notice.

8 SHOOTING

- Switch the safety to FIRE.
- Load the pistol according to step 7.
- Pull the trigger to fire (a BB pellet will be fired and the slide will be pushed backward).

To prevent misfiring, keep your finger off the trigger and out of the trigger guard when you are not ready to fire.

● When the BB is loaded into the barrel, the following process will be proceeded and repeat automatically everytime you pull the trigger:
 BB fired → Slide movement (blowed backward) → Load the next BB (slide re-positioned)

WARNING-ATTENTION

- Power Depression
When the temperature inside the magazine is too low, the gas power will be depressed.
 △ The movement of the slide will be delayed.
 △ The slide catch will not bounced.
 △ The shooting range will not be far.
- Shooting posture
 △ Please do not operate the pistol up side down for optimum performance.

※ ATTENTION

- The rails on the slide is very sharp. Please keep your face and fingers away from the slide while the slide is operating.
- Please keep your finger off the trigger and out of the trigger guard, and take extra caution to where the gun is aiming while proceeding non-firing operations.

9 STORAGE

- Press the magazine catch button to release the magazine.
- Make sure the inner barrel is clear. If not, pull the slide backward, and turn the pistol up side down to remove (push the BB pellet out from the barrel by the clearing rod is also recommended).
- Press the slide catch lever to release the slide.
- Pull the trigger and fire several times towards safety directions, and make sure no BBs are left inside the barrel.

10 DISASSEMBLY (Do it when necessary)

Only disassemble your airsoft replica when adjusting the H-UP and proceeding to maintenance.

- Press the Magazine Release Button to unload the magazine.
- Remove the compensator screws, and detach the compensator.

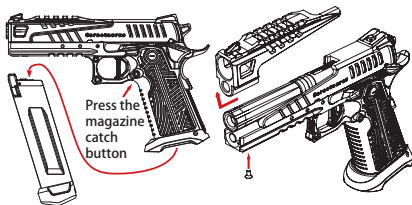

- Pull back the slide and press the slide stop upward to lock it.
- Insert the dedicated tool into the hole on the recoil spring guide as shown.

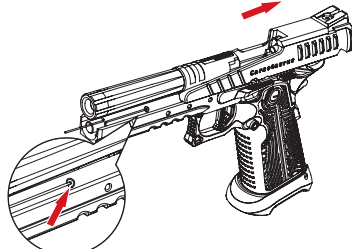

- Push the Slide backward and align the notch corresponds to the slide stop as shown.

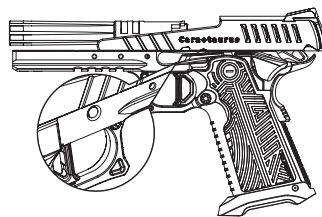

- Press the slide stop button on the right to remove it.
- Push the slide forward to detach it. Meanwhile, The recoil spring guide set is contained.
- The recoil spring guide set can be easily removed by slightly pushing it forward and taking it out.
- Push the outer barrel set forward to remove. You may disassemble the recoil spring guide by detaching the dedicated tool if necessary.

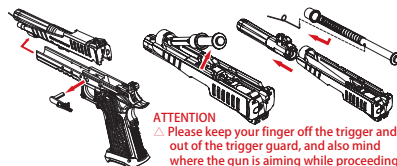

ATTENTION
 △ Please keep your finger off the trigger and out of the trigger guard, and also mind where the gun is aiming while proceeding non-firing operations.
 △ Watch out for the rod may bounce out of the recoil spring guide set.

11 H-UP ADJUSTMENT

- Please disassemble and remove the slide as step 10 instructed.
- Slightly rotate the screw to adjust the H-UP.

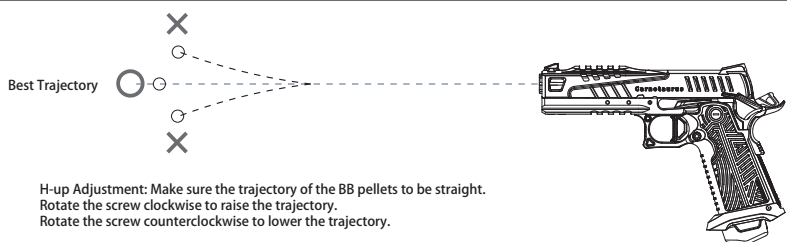
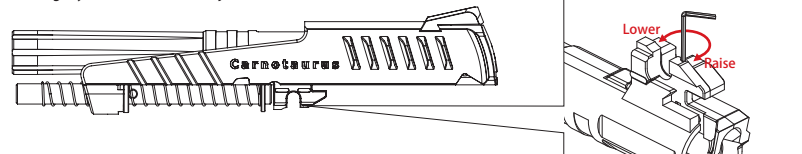

H-up Adjustment: Make sure the trajectory of the BB pellets to be straight. Rotate the screw clockwise to raise the trajectory. Rotate the screw counterclockwise to lower the trajectory.

12 ASSEMBLY

※ Please check the following status before assembly:
 △ The hammer must be down pressed.

- Insert the dedicated tool into the hole on the rod and reverse Step 10, to assemble the recoil spring guide set.
- Assemble the outer barrel set by pushing it back into the slide.
- Assemble the recoil spring guide set to the slide.

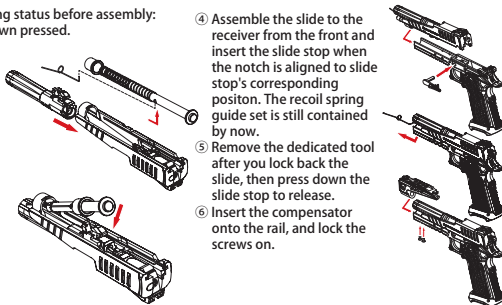

- Assemble the slide to the receiver from the front and insert the slide stop when the notch is aligned to slide stop's corresponding position. The recoil spring guide set is still contained by now.
- Remove the dedicated tool after you lock back the slide, then press down the slide stop to release.
- Insert the compensator onto the rail, and lock the screws on.

WARNING · ATTENTION

● ICS will not be responsible for any part assembling errors, missing parts, and issues such as malfunctions, accidents, injuries. All the maintaining expenses will be borne by the customers.

13 BASIC TROUBLESHOOTING GUIDE

SYMPTOMS	POSSIBLE CAUSE	SOLUTIONS
No response	The safety is ON. (No firing)	Switch the safety to "OFF". (refer to step 2)
	Insufficient gas in the cartridge	Replace a new cartridge after confirming the cartridge is empty (refer to step 7, item 4 and step 4)
CO2 comes out from the barrel	Temperature is too low. (during the winter)	Reheat the cartridge to room temperature.
	Cartridge over-pressured	It will return normal after firing several times.
BBs fly up	H-UP is over adjusted.	Adjust the H-UP screw clockwise. (refer to step 9)
Shooting range is too short	H-UP is not enough.	Adjust the H-UP screw counter-clockwise. (refer to step 9)
	Foreign matters or oil in the inner barrel.	Clean the inner barrel and H-UP bucking.
	Cartridge over-pressured.	It will return normal after firing several times.
BBs roll out of barrel	H-UP is not enough.	Adjust the H-UP screw counter-clockwise. (refer to step 9)
Jammed	H-UP is over adjusted.	Adjust the H-UP screw clockwise. (refer to step 9)
	Bad BBs, oversize BBs	0.2g to 0.25g 6mm caliber BBs are recommended for optimum performance.
Trigger cannot be pulled.	Foreign matters or oil in the inner barrel.	Clean the inner barrel.
	BBs or foreign matters jam inside the case.	Take out the BBs or foreign matters.
CO2 leaking from perforated seat	Bad installation of the cartridge	Replace a new cartridge after confirming the cartridge is empty.(refer to step 7, item 4 and step 4)
	Not enough silicon oil for perforated seat .	Grease the perforated seat.
Magazine lip cannot hold the BBs.	Magazine lip abraded	Replace the Magazine lip.

14 PARTS DIAGRAM

*The components/accessories for each model may have kind of differences depending on the actual goods. Images are only for reference.

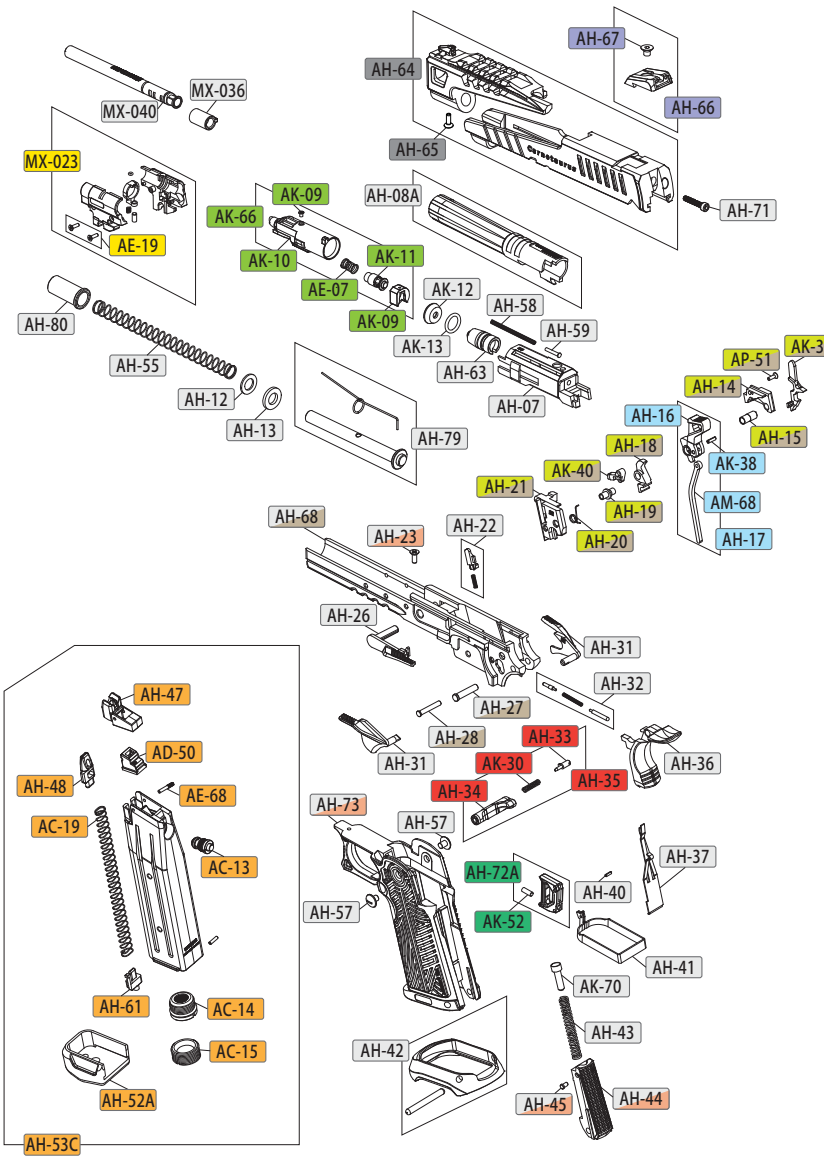

15 PARTS DESCRIPTION

ITEM#	DESCRIPTION	Q'TY	ITEM#	DESCRIPTION	Q'TY
AH-07	Hi-Capa Cylinder Housing	1	AH-79	4.3" Hi-Capa Recoil Spring Guide Rod with Reverse Plug Retention Clip	1
AH-08A	5.1" Hi-Capa Outer Barrel-Red	1	AC-13	CO2 Valve	1
AH-12	Hi-Capa Shock Buffer Washer	1	AC-14	CO2 Cylinder Perforated Seat	1
AH-13	Hi-Capa Shock Buffer Rubber	1	AC-15	CO2 Cylinder Housing Screw	1
AH-14	Hi-Capa Hammer Housing-Right	1	AC-19	CO2 Magazine Spring-Short	1
AH-15	Hi-Capa Hammer Sleeve	1	AD-50	XPD Magazine Nozzle Seal	1
AH-16	Hi-Capa Hammer	1	AE-07	XAE Valve Spring	1
AH-17	Hi-Capa Hammer Combination	1	AE-19	XAE H-UP Chamber Screw	2
AH-18	Hi-Capa Sear	1	AE-68	XAE Magazine Lip Pin	1
AH-19	Hi-Capa Sear Sleeve	1	AK-09	Vulture Valve Cover with Screw	1
AH-20	Hi-Capa Hammer Knocker Spring	1	AK-10	Vulture Cylinder	1
AH-21	Hi-Capa Hammer Housing-Right	1	AK-11	Vulture Valve	1
AH-22	Hi-Capa Hammer Disconnect with Spring	1	AK-12	Vulture Valve Plate	1
AH-23	Hi-Capa Middle Frame Screw	1	AK-13	Cylinder Cover Housing O-Ring	1
AH-26	Hi-Capa Slide Release	1	AK-30	Vulture Magazine Catch Spring	1
AH-27	Hi-Capa Hammer Pin	1	AK-36	Vulture Hammer Disconnect Pin	1
AH-28	Hi-Capa Sear Pin	1	AK-38	Hammer Brace Rod Pin	1
AH-30	Hi-Capa Hammer Housing Combination	1	AK-40	Vulture Hammer Knocker	1
AH-31	Hi-Capa Slide Safety	1	AK-52	Vulture Trigger adjustment Screw	1
AH-32	Slide Release Pin and Spring	1	AK-66	Vulture Cylinder Combination	1
AH-33	Hi-Capa Magazine Catch Lock	1	AK-70	Vulture Hammer Spring Holder	1
AH-34	Hi-Capa Magazine Catch	1	AM-68	BM9 Hammer Brace Rod	1
AH-35	Hi-Capa Magazine Catch Combination	1	AP-51	PM2 Magazine Cover Screw	1
AH-36	Hi-Capa Grip Safety	1	MX-023	Master Hi-Capa TDC Hop Chamber	1
AH-37	Hi-Capa Sear Spring	1	MX-036	Master Ver.2 R-Hop Chamber Rubber	1
AH-40	Hi-Capa Trigger Bar Pin	1	MX-040	Master Inner Barrel 113mm	1
AH-41	Hi-Capa Trigger Bar	1			
AH-42	Hi-Capa Magwell & Pin	1			
AH-43	Hi-Capa Hammer Spring	1			
AH-44	Hi-Capa Hammer Spring Housing	1			
AH-45	Hi-Capa Hammer Spring Lock Pin	1			
AH-47	Hi-Capa Magazine Lip	1			
AH-48	Hi-Capa Magazine Follower	1			
AH-52A	Hi-Capa Magazine Plate-Red	1			
AH-53C	Hi-Capa CO2 Magazine-30rds	1			
AH-55	Hi-Capa Recoil Spring	1			
AH-57	Hi-Capa Grip Screw	2			
AH-58	Hi-Capa Cylinder Housing Spring	1			
AH-59	Hi-Capa Cylinder Housing Spring Pin	1			
AH-61	Hi-Capa CO2 Magazine Plate Stop	1			
AH-63	Hi-Capa Cylinder Cover Housing	1			
AH-64	Carnotaurs Slide with Front Sight Combination	1			
AH-65	Front Slide Screw	1			
AH-66	Hi-Capa 4.3 Rear Sight	1			
AH-67	Hi-Capa 4.3 Rear Sight Screw	1			
AH-68	Hi-Capa 5.1 Middle Frame	1			
AH-69	Hi-Capa 5.1 Middle Frame Combination	1			
AH-71	Hi-Capa Cylinder Housing Screw	1			
AH-72A	Hi-Capa Flat Trigger-Red	1			
AH-73	Hi-Capa Totem Grip	1			
AH-74	Hi-Capa Totem Grip Combination	1			
AH-80	4.3" Recoil Spring Guide	1			